



OPTIMUM 600M

*Best Compact Cold Press Juicer
2023 Productreview.com.au Award Winner*



USER MANUAL

CONTENTS

WELCOME TO YOUR NEW JUICER	1
SAFETY FIRST	1
GETTING TO KNOW YOUR 600 MINI COLD PRESS JUICER	3
ASSEMBLY INSTRUCTION	4
OPERATION INSTRUCTION	6
DISASSEMBLY OF THE JUICER	8
WHAT FRUITS SHOULD I AVOID PUTTING IN MY JUICER?	9
PREPARING ALL-NATURAL JUICES	10
PREPARING NUT MILK AND SORBET	11
CLEANING & STORAGE	12
TROUBLESHOOTING	12
PRODUCT SPECIFICATIONS	13
WARRANTY TERMS & CONDITIONS (INTERNATIONAL)	13
CONTACT US	14

WELCOME TO YOUR NEW JUICER

Congratulations on investing in a professional Optimum 600M Slow Juicer. Create delicious fruit juices, vegetable juices and much more.

Juice, Snap, Post!

We want you to show us your freshly made juice :)

All you need to do is follow us on Facebook and Instagram, make some fresh juice, snap a photo and post with the hashtags #froothie #optimum600M

We give spontaneous prizes to our favourite pics!

FOR BEST RESULTS, AND TO ENSURE YOUR SAFETY, PLEASE READ THE INSTRUCTIONS IN THIS MANUAL CAREFULLY.

FOR ADDITIONAL INSPIRATIONAL IDEAS FOR DELICIOUS RECIPES, PLEASE CHECK OUT OUR FROOTHIETV YOUTUBE CHANNEL.



SAFETY FIRST



WHEN USING ELECTRICAL APPLIANCES, YOU SHOULD ALWAYS BE AWARE OF AND FOLLOW BASIC SAFETY PRECAUTIONS INCLUDING:

1. Read and follow all instructions and warnings in this manual carefully.
2. To protect against the risk of injury due to electric shock, do not immerse the Optimum 600M Slow Juicer in water or any other liquid.
3. Only connect the appliance to a grounded power outlet. Always make sure the power plug is inserted into the power outlet properly.
4. The input voltage of this appliance is between 220-240V, at 50-60Hz. Ensure the power source is compatible with the appliance before connecting it to avoid damage.
5. This appliance is not intended for use by persons (including children) with reduced physical, sensory or mental capabilities, or lack of experience and knowledge, unless they are supervised or have been given instruction concerning the use of the appliance by a person responsible for their safety.
6. Do not operate the juicer if the power cord or plug are damaged, or if it malfunctions or is damaged in any way. Return the appliance to the nearest authorised service facility for inspection or repair. Do not attempt to repair the appliance yourself to avoid the risk of injury.
7. Do not operate the appliance with wet hands.
8. If you have any issues operating the juicer, first refer to the troubleshooting section. If the problems persist, contact and return the appliance to distributor for inspection or repair. Do not disassemble the juicer yourself.
9. Unplug the power cord from the power outlet before assembling, disassembling, cleaning or putting your hands near any moving parts of the appliance to avoid injury.

SAFETY FIRST

10. Do not squeeze lemon juice directly into the appliance.
11. Always ensure the appliance conforms to food safety and hygiene standards by following the cleaning and maintenance instructions in this manual.
12. After every use, use water to clean the appliance and all detachable parts that come in direct contact with ingredients.
13. Exercise extra care when handling parts of the appliance with sharp edges, emptying the cups of their contents, and during the cleaning of the appliance.
14. Switch off and unplug the appliance during long periods of inactivity
15. Never use any objects (e.g. chopsticks) to remove blockages in the outlets. Follow proper cleaning procedures instead.
16. Before connecting the device to power, please confirm that the local voltage is in conformity with the voltage instruction at the bottom part of the device.
17. Please do not use the appliance continuously for longer than 10 minutes, excessive use can cause overheating which can lead to motor failure.
18. It is forbidden to use several plugs in one socket. Abnormal heating may cause fire.
19. When there is dust or water in the power plug pin, clean with a duster. Failure to do so presents the risk of electric shock and fire.
20. Do not use with or keep the device near gas appliances. This may cause deformation or color change.
21. Do not disassemble, repair, or reform. Danger of abnormal phenomena, fire and injury.
22. It is forbidden to clean the device with chemical or volatile substance. This action presents the risk of color change, discoloration, and dangerous events such as fire.
23. Never spray flammable liquids or water onto the device. This action can create hazardous conditions that may lead to fire, electric shock, and/or explosion.

**FAILURE TO FOLLOW SAFETY INSTRUCTIONS AND WARNINGS COULD
RESULT IN SERIOUS INJURY. MISUSE OF YOUR COLD PRESS
JUICER MAY DAMAGE YOUR APPLIANCE AND VOID YOUR
WARRANTY.**

GETTING TO KNOW YOUR 600 MINI COLD PRESS JUICER

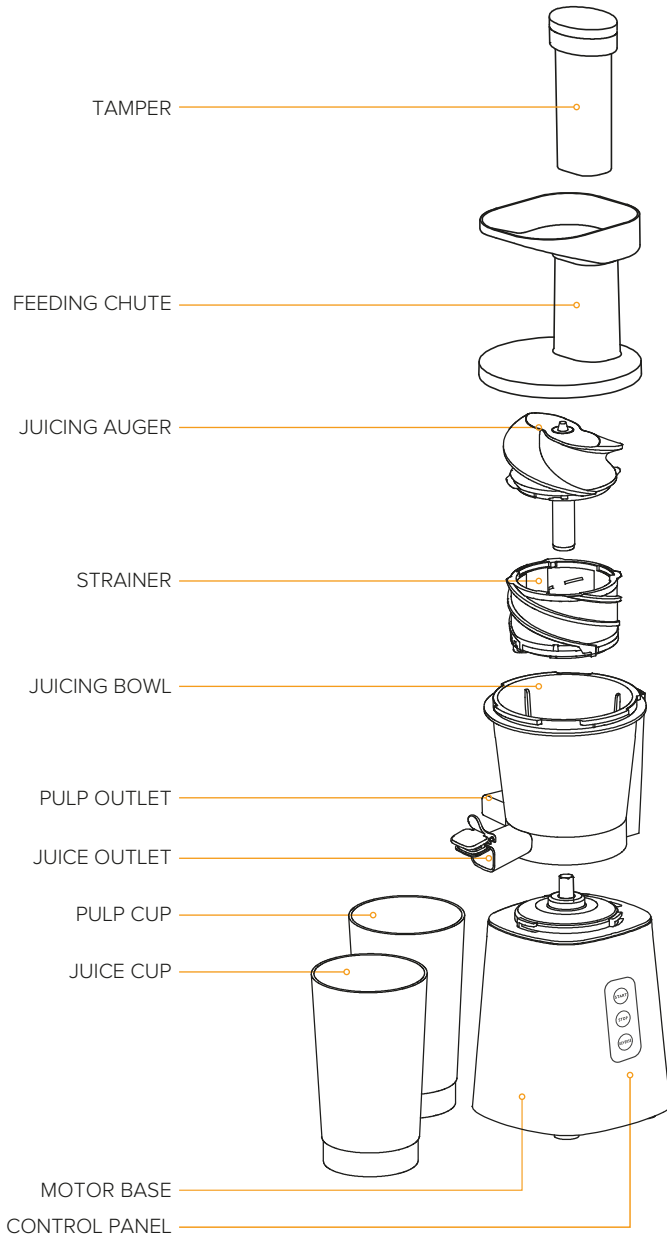

ASSEMBLY INSTRUCTION

REVERSE THE STEPS CAREFULLY WHEN DISASSEMBLING.

1.

Open the product package, take out the product and accessories, and dispose of the packing material.

2.

Clean the product surface and wash the accessories with water. Do not wash the main body.

3.

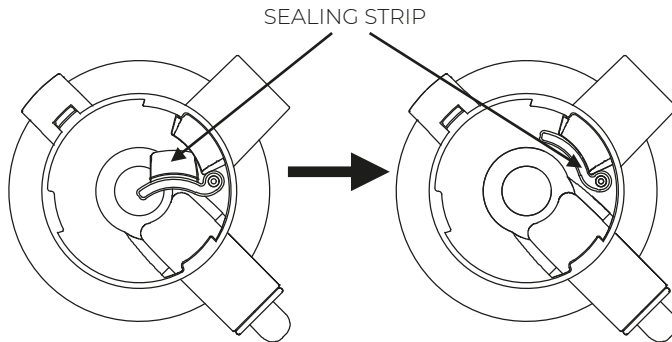

Before assembling the juicing bowl on the main body, make sure the sealing strip on the bottom is inserted properly. If the sealing strip is not inserted properly, the sealing will not be effective, and juice will spill outside of the juicer.

4.

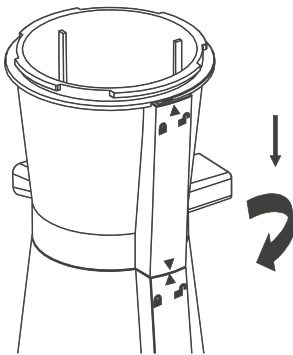

Put the juicing bowl on the main body, rotate it clockwise to align the mark points on both pieces. See Figure 4 for example.

5.

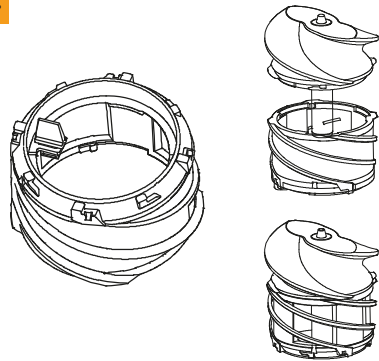

Ensure the silicone brush/tab is inserted into the strainer. Then attach the strainer to the auger by aligning the arrows.

ASSEMBLY INSTRUCTION

6.

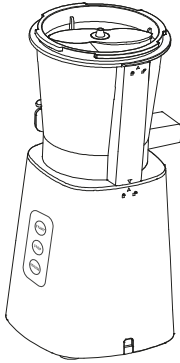

Install the juicing auger into the juicing bowl upright; connect the juicing auger axle sleeve with the motor rotating rod.

7.

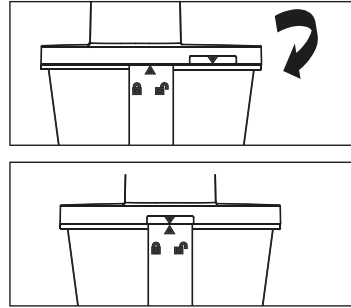

Install the hopper (chute) on the juicing bowl. Use the marked points found on the hopper and the juicing bowl to properly align both pieces, then rotate the hopper clockwise until secure.

8.

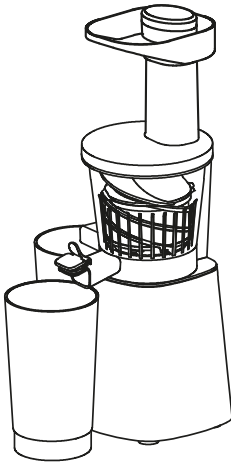

Place the tamper into the feeding chute, then position the juice cup and pulp cup beneath the juice outlet and pulp outlet.

9.

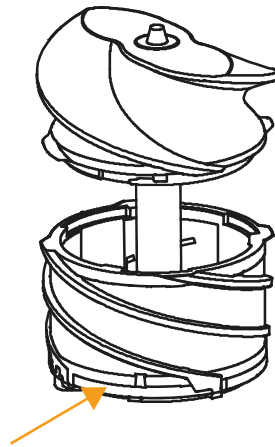

For cleaning, you can also remove the thin ring with the wiper from the filter. After cleaning, attach it again (you can hear a clicking sound once connected).

OPERATION INSTRUCTION

1. Insert the plug into the socket (make sure the socket has reliable grounding).

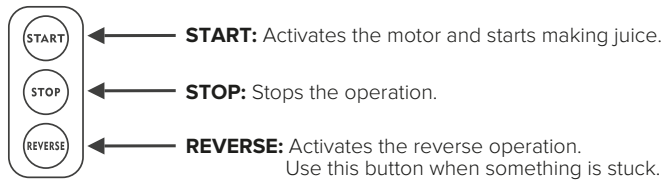
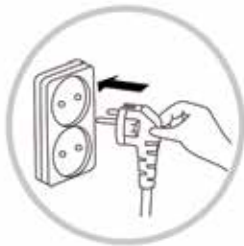

2. Wash all fruits and vegetables
3. After washing and cutting, slowly add prepared ingredients into the machine. If necessary, use the pusher to ensure all ingredients are fully inserted in the device. Remember to remove any hard seeds from ingredients before juicing.

Note:

- A) The ingredients should be put into the device one by one. When you've successfully inserted one ingredient, you may proceed with adding the next. It is recommended to cut all ingredients into approximately 4cm pieces.
 - B) Hard-fiber ingredients (such as celery) should be cut into properly sized portions. It is recommended to size such ingredients to approximately 3cm in length. Ginger should be cut into pieces no larger than 0,5cm.
 - C) Fiber-poor ingredients (such as carrots) are preferred to be extracted alongside fiber-rich ingredients like celery. Simply cut the carrots into four equal parts. Due to differences in the moisture content of your ingredients, you will notice variations in the extracted juice amounts.
 - D) **IMPORTANT:** Ingredients with hard skin, such as lemons, oranges, grapefruits or pomegranates must be peeled before juicing. Stale ingredients will produce the least amount of juice. Ingredients that have been refrigerated for extended periods of time should be soaked in pure water to rehydrate before extraction.
 - E) Ingredients will respond differently to the juicing process. For the best results, do not exceed the outlined maximum levels in the juicing bowl. If the bowl becomes overfilled, your juice and pulp will have difficulty exiting the device. As a result, the device may begin to leak from the mouth of the juicing bowl, creating spillage. This is especially true when juicing ingredients such as cucumber, cherries, or tomatoes.
 - F) **Notice:** Do not attempt to dislodge or insert ingredients using foreign objects such as chopsticks or spoons. If necessary, you may use the pushing bar to guide ingredients into the juicer.
4. If the machine suddenly stops, first, press STOP. Then, press the REVERSE button, to dislodge jammed ingredients. When the ingredients have shifted back between the auger and the bowl, you may press the START button.

OPERATION INSTRUCTION

Note: If the above operation does not correct the issue, follow the instructions in this guide to disassemble the device. Then, follow the instructions for cleaning the juicing bowl before attempting to reuse the juicer.

Note: Always press power STOP button before applying the REVERSE function. Wait until the machine has fully stopped, then press REVERSE button.

5. Stop the machine after juicing.
6. Clean the machine after juicing.

FINE STRAINER

The fine strainer will assist you in making fresh juices and nut milks. The fine mesh screen will reduce the pulp in your juice.

BLANK STRAINER

The no-hole/blank screen, sometimes called a homogenising plate is used for making nut butters, ice creams and baby food and does not separate any liquids from the pulp. This makes it ideal for making fresh, healthy frozen fruit sorbet and preservative free baby food.

REMARKS:

Your device is equipped with built-in overload protection and overheat protection functions. If the device is ever overfilled, or if its operation exceeds the suggested 10-minute limit, these preventative protection features will be triggered. In the event of overheating, the device is designed to cease functioning to allow the motor to cool down. To resume juicing, press STOP button and unplug the device from the outlet. Wait approximately 20-30 minutes, to allow the juicer's protection features to recover and reset. When the device has cooled down, plug it into the socket again. Press START button to test the device. If it has recovered, the motor will run. If not, please unplug the device again and continue to wait for the motor to cool. When the functions have reset, you will be allowed to resume juicing.

IMPORTANT: We recommend not to fill the juice bowl more than the maximum recommended level. Do not leave the juice bowl filled with juice. The base unit must be kept dry at all times, so please note you should dry any water left on the outside of the juice bowl and any water left on the hopper before you place those on the unit.

DISASSEMBLY OF THE JUICER

1. Unplug the power cord from the power outlet before disassembling.
2. When the juicer has stopped, rotate the hopper anti-clockwise and then pull the hopper upward.
3. Pull the auger upward.
4. Rotate the juicing bowl anti-clockwise and then pull it upward to remove it from the juicer.

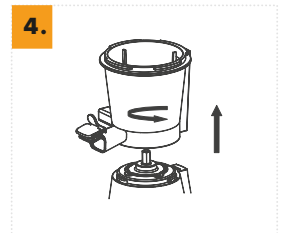
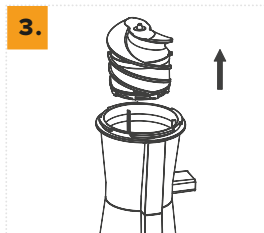
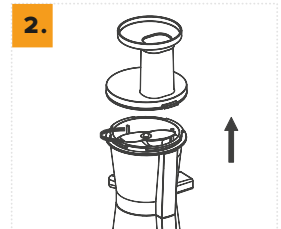
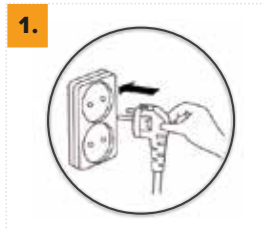

Note: Disassembling the components of the juicer follows the sequence of assembly in reverse.

USEFUL TIPS / IMPORTANT REMINDERS

- Before juicing, always remove any hard seeds/stones from fruits like peaches, plums, mangos, apricots, etc. to avoid potential damage to the squeezing screw.
- When making mixed juices start with softer fruits and then juice the harder ones.
- Allow the juicer to run for 30 seconds after the last ingredient has been fed.

ATTENTION: The juicer is not suitable for juicing very hard, fibrous, or starchy fruits or vegetables, such as sugar cane. Some fruits, like avocado, bananas, figs, mango, papaya, dragon fruit, strawberry, and seedless grapes, contain too much starch and can clog up the stainless steel sieve.

- Do not use ice cubes. Ice cubes are too hard and can damage the squeezing parts of the juicer.
- Ingredients with long fibres should be cut into thin strips of 5-10 cm or cubes of 3 x 3 cm. Long-fiber foods are prone to tangling and can block the spout.
- Oranges, lemons, grapefruits, and melons must be peeled and have their pits/seeds removed before juicing. The hard pits or seeds can damage the squeezing parts, and the peel can block the pulp spout.
- Do not use any other accessory as a pusher. Using non-designated objects as pushers can cause damage to the juicer and result in injury.
- Do not overfill with ingredients. This presents the risk of jamming the juicer and/or stopping the engine.
- Each juicing cycle should not exceed 30 minutes. Extended use beyond this time can cause damage to the motor.
- Never insert a spoon or similar item into the chute opening, juice spout, or pulp spout. Doing so can damage the juicer.
- It is best to alternate between the juicer and more fibrous fruits and vegetables. For example, you can alternate between juicer ingredients like apples, carrots, cucumber and citrus fruits and the more fibrous ingredients like greens such as kale and spinach, celery and wheatgrass. We also suggest saving the carrot for last, as this helps push out the last of the pulp.

USEFUL TIPS / IMPORTANT REMINDERS

- To increase the efficiency of the extraction, remember to cut high fiber ingredients as small as possible, then slowly insert each piece into the chute.
- **Tips for juicing apples:** Dry or floury apples are often found in winter because apples have been stored for a long time and have lost a lot of their moisture content. If you juice floury apples, chances are you will get pulp rather than juice. This happens with every juicer - regardless of whether it is a centrifuge or masticating/cold press.
- Only juice firm apples. Be sure to juice slowly and alternate with other produce such as carrots to keep the strainer clean.
- We recommend using Granny Smith apples - they are firmer and keep their quality for much longer.

WHAT FRUITS SHOULD I AVOID PUTTING IN MY JUICER?

Sometimes people are surprised that their juicer cannot handle certain types of fruit such as apples, avocados or bananas. The reason for this isn't that there is something wrong with your juicer, but more about the properties of such fruit that make them poor options for juicing.

BANANAS

Bananas have their own composition. They are so rich in Potassium that can benefit the body in multiple ways, but unfortunately bananas do not have enough water in them, thus making it impossible for juicing. Bananas are much better suited for smoothies or other blended desserts!

BERRIES

Strawberries, blueberries, raspberries and currants are very soft and have little liquid content. Furthermore, the pulp in these fruits can clog the sieve. However, fret not — the solution is to mix the berries with other high-water-content produce.

HOW TO JUICE BERRIES?

- Use fresh and juicy berries
- Alternate berries with other fruit such as oranges, apples or watermelons. Berry juice has a very intense taste and is often better as an addition and not as a main ingredient. Mix the different types of fruit together while juicing.

AVOCADO

Avocado is a great source of omega-3 fatty acids and, when ripe, it blends nicely, making smoothies and dips creamy and smooth. But if you try to juice it, it will only jam your juice machine. You can add avocado to fresh juice, though — here's how: In a blender, combine 1 cup of fresh juice with 1/2 avocado, cut into chunks. Blend until smooth. Pour this mixture into the rest of your juice and mix well. The avocado will make the juice thick and creamy.

WHAT FRUITS SHOULD I AVOID PUTTING IN MY JUICER?

CHERRIES

Like berries, cherries have a soft, mushy consistency, so it takes a lot of cherries to make just one glass of juice. The main reason people tend not to juice cherries is because they need to be deseeded before being juiced. Alternative: You can add cherries to smoothies and other blended drinks or use a small amount of their juice in your juice recipe.

MANGO

Mangos are a very mushy fruit that is not optimal for juicing.

Alternative: Frozen mangoes are perfect for smoothies and add a great creamy flavour. If you're looking for some type of thick, mango juice-like beverage, we recommend using a blender to puree the mangos, which you can then add to any juice. This method also works well for papayas.

PREPARING ALL-NATURAL JUICES

TOMATO JUICE

Tomato juice is a common form of vegetable juice appreciated for its cool, refreshing taste. It contains lycopene haematochrome, known as an all-natural anti-ager. Be mindful of when, and how much, tomato juice you consume. Due to a high concentration of citric acid, it may irritate certain bodily functions. For the best results, enjoy one cup of tomato juice in the morning. You may also wish to explore the taste and effects of different types of tomatoes. Grape tomatoes are known to be sweet, while yellow and green tomatoes also offer a unique taste. Not only will you end up with juices with varying taste, they'll have different colours and consistencies as well.

Slice into appropriately sized pieces, then slowly add the tomatoes into the feeding tray of the juicer.

CARROT JUICE

Carrots are the king of the vegetable kingdom, which makes it easy to understand why they're so favored in all-natural juice recipes. They're juicy, delicious, and highly nutritious, and its sweet taste is always appreciated. Usually, carrots are extracted in combination with acidic fruits or vegetables. Containing rich amounts of Vitamin A and renieratene, just two carrots a day can satisfy 400% of your body's daily Vitamin A requirements.

1. Cut the carrot into long, slender slices, so it will easily fit into the device.
2. Slowly insert the sliced pieces into the inlet orifice, only adding one at a time. Return the extracted juice into the device, to filter through the pulp a second time. This will reduce the amount of remains left in the screen holder and produce a finer liquid product.



For more juice recipes please refer to the supplied juicer recipe book and visit our YouTube channel.

PREPARING NUT MILK AND SORBET

NUT MILK

To prepare nut milk using your juicer, follow these simple steps:

1. Start by soaking one cup (approximately 200 grams) of raw unsalted or unroasted nuts in a large cup or bowl. Ensure that the nuts are well covered in cold water. Allow them to soak overnight or for at least 8 hours. This soaking process softens the nuts and makes them suitable for juicing.
2. The next day, drain the soaked nuts and rinse them thoroughly under running water until the water runs clear.
3. Add fresh water to the bowl of soaked and cleaned nuts. The amount of water you add will determine the consistency of the milk. Start with about one cup of water, and you can adjust the amount later if needed.
4. With the **fine filter** inserted into the juicer, turn it on and gradually spoon a ladle full of soaked nuts and water into the juicer. Be sure not to add too much too quickly to avoid clogging the juicer.
5. Continue adding the nuts and water mixture into the juicer until all the nuts have been juiced. The resulting milk should be frothy.
6. To ensure proper mixing, keep the juice tap closed until there is about 1-2 inches of milk in the juicer. Then, open the tap to release the milk.
7. Once all the milk has been extracted, you can strain it through a nut milk bag or fine mesh sieve to remove any remaining pulp and achieve a smoother consistency.
8. Store the freshly made nut milk in an airtight container in the refrigerator for up to 3-4 days.

SORBET

When making sorbet in your 600M Juicer, follow these helpful tips for the best results:

1. Use the blank strainer attachment: To make frozen fruit sorbet, ensure you attach the blank strainer to your juicer. This attachment is specifically designed to process frozen fruits into smooth sorbet textures.
2. Prepare frozen fruit pieces: Before processing, ensure your frozen fruit pieces are small and manageable. For optimal results, allow the frozen fruit to thaw on the counter for approximately 20 minutes. This slight thawing will make the fruit easier to process and result in a smoother sorbet texture.

WHAT CAN I DO WITH THE PULP?

Before discarding all that fibrous, colorful pulp, consider putting it to good use in any of these easy ways. Try adding it to stews, muffin batters, or even veggie burgers. Pulp is also enjoyed by pet chickens and makes a great weekly treat for your feathered friends. If none of these options appeal to you, you can add the pulp to your compost.

CLEANING & STORAGE

1. Press STOP button, then remove the power plug from the outlet.
Note: Only STOP the device after the juicing bowl is completely cleared of all ingredients.
2. When all functions have stopped, hold the bowl, then twist the hopper toward the opening of the device. Now, it is safe to proceed with disassembly. (Remember, always disassemble the components of the device in the opposite sequence of assembly.)
Note: Promptly clean the juicer after each use. Delayed cleanings can result in dried ingredients crusting to the components, making it difficult to disassemble or clean. This action may also result in diminishing the device's performance.
3. Clean the squeezer, juicing bowl, hopper, and pushing cylinder with a soft brush and neutral detergent. Dry all components thoroughly.
4. Wipe the main base of the device with a dry, soft cloth.
Note: After extracting pigment rich ingredients such as carrot, spinach, etc., wipe the container surface with oil, and then wash with neutral detergent.

TROUBLESHOOTING

PROBLEM	SOLUTION
The motor suddenly stopped while the juicer was running	<ul style="list-style-type: none"> • Check to ensure the plug is fully inserted in the outlet • Verify that the device is not overloaded and that the motor has not overheated. If the device has been in use for longer than 10 minutes, you may need to allow the motor to cool before resuming. • Press STOP button, then switch the device to REVERSE. This should start reverse operation, which should dislodge any jammed ingredients.
The device is not producing enough juice	<ul style="list-style-type: none"> • Different ingredients yield different amounts of moisture, which can affect juice levels. • The freshness of your ingredients can also impact moisture content. Stale fruit and vegetables typically yield minimal amounts of juice. • Ingredients that have been refrigerated for extended periods should be rehydrated in pure water before juicing. • Mix up ingredients with low fiber content (such as carrots) with fiber rich ingredients (such as cabbage, celery). Alternate the carrots after juicing the high fiber ingredient, to increase the level of juice extracted. • Verify that the sealing strip is properly positioned, to secure all juice and ingredients.
Imbalance in the liquid to pulp ratio of my juice	Please check whether the sealing strip is assembled properly.
Juice is shooting from the upper component of the main engine	When the sealing strip is not properly assembled, juice will leak from the device. Ensure proper sealing, to prevent this from happening.

PRODUCT SPECIFICATIONS

1	Model	MJ2000
2	Voltage	220-240V
3	Power	200W
4	Frequency	50/60Hz
5	Speed	40-46 RPM
6	Product weight with accessories	3.3 kg
7	Product dimensions	14.7 x 18.1 x 40.4cm (WxDxH)



Only for EU countries. Do not dispose of electric appliances together with household waste material! In observance of European Directive 2002/96/EC on waste electrical and electronic equipment and its implantation in accordance with national law, electric appliances that have reached the end of their life must be collected separately and returned to an environmentally compatible recycling facility.

WARRANTY TERMS & CONDITIONS (INTERNATIONAL)

This warranty as outlined below solely covers distributors of the Optimum range of products. Please contact your distributor for full product warranty.

Effective as of 1st January 2014

1. Optimum® warrants this product against defects in materials and workmanship for a period of 1 year from the original date of purchase, when used in accordance with the accompanying instruction manual.
2. Any warranties exceeding this standard period are offered as extended terms by the selling distributor and claimable only through that provider.
3. Defects that occur within this manufacturer's warranty period under normal use and care will be repaired or replaced at our discretion only if the selling distributor is unable to do so. This is done solely at our option with no charge for parts. This warranty does not extend to accessories included or purchased separately. Replacements can be offered for major faults, as determined by your distributor and at their own discretion.
4. In the event that the goods requiring repair are under warranty, and this distributor is unable to provide the repairs; the customer is responsible for any freight charges to or from Optimum® (or their approved service provider).

14 // OPTIMUM 600 MINI

5. Whilst in transit, the goods are at the owner's risk and any further damage during this transportation is not covered under warranty.
6. Customers should ensure that the product being returned is properly packaged, so as to ensure that no damage occurs to the product during transit. To be able to process the warranty claim, ensure you have included an explanation of any problem. Optimum® will not fault-find and will only repair described faults as covered under warranty.
7. This full warranty is void if this product has been subject to abuse, negligence, accident, alteration, failure to follow operating instructions, or if the product has been exposed to abnormal or extreme conditions.
8. Cosmetic changes that do not affect performance, such as discoloration of parts of the product in the hands of the user or the effects of the use of abrasive cleaners will not be warranted or considered defects. The cleaning or removal of food products along with any damage caused by allowing them to build up is not covered by this full warranty.
9. This warranty does not cover normal wear and tear of the product or parts.
10. This warranty does not cover any defect caused by an accident, misuse, abuse, improper installation or operation, lack of reasonable care, unauthorized medication, loss of parts, tampering or attempted repair by a person not authorized by Optimum®.
11. The warranty will not apply if damage, malfunction or failure resulting from alterations, accident, misuse, abuse, fire, liquid spillage, maladjustment of customer controls, use on an incorrect voltage, power surges and dips, thunderstorm activity, acts of God, voltage supply problems, tampering or unauthorized repairs by any persons, use of defective or incompatible accessories, exposure to abnormally corrosive conditions or entry by any insect, vermin or foreign object in the product.
12. This warranty does not cover damage resulting from the use of an alternate power source (e.g. solar, inverter, generator) and the use of these devices to power your appliance is not recommended.
13. You must keep your purchase receipt as proof of purchase and as proof of the date on which the purchase was made. The purchase receipt must be presented when making a claim under this warranty.
14. In the event the receipt of purchase is not presented, then this warranty is invalid. Consumer Law allows us to request reasonable proof of purchase to service a warranty claim.
15. This warranty does not imply, intend to or detract from any consumer rights listed in and able to be enforced from Regulated Consumer Law, any condition which is found to be in breach of the consumer law, the single condition shall be void only and all other conditions remain in place.

CONTACT US

Please contact the distributor located in the country where you made your original purchase for all support, servicing and warranty.

