



# THERMOCOOK PRO M 3.0X

---

*The Must-Have All-In-One Kitchen Appliance*  
*Professional Thermo Cooker*

---



QUALITY  
MEETS  
SIMPLICITY

# USER MANUAL

# CONTENTS

WELCOME TO YOUR NEW KITCHEN ASSISTANT!	1
SAFETY FIRST	2
GETTING TO KNOW YOUR THERMOCOOK PRO M 3.0X – PARTS	5
GETTING TO KNOW YOUR THERMOCOOK PRO M 3.0X – DIGITAL DISPLAY / CONTROL PANEL	6
GETTING TO KNOW YOUR THERMOCOOK PRO M 3.0X – CONNECT TO WIFI / APP	9
GETTING TO KNOW YOUR THERMOCOOK PRO M 3.0X – USER ACCOUNT	10
OPERATING INSTRUCTIONS	12
CONTROL PANEL OVERVIEW	15
PROCESSING GUIDE / SUGGESTED USAGE OF ATTACHMENTS	20
ESSENTIAL SETTINGS / QUICK REFERENCE	21
CLEANING AND MAINTENANCE	29
TROUBLESHOOTING	31
PRODUCT SPECIFICATIONS	32
WARRANTY TERMS & CONDITIONS	33
CONTACT US	34

# WELCOME TO YOUR NEW KITCHEN ASSISTANT!

Congratulations on the purchase of your professional all-in-one kitchen appliance, the **Optimum Thermocook Pro M 3.0X**.

From the first time you use your Optimum Thermocook, it will become your secret ally in the kitchen, helping you to cook like a five-star chef.

Its many diverse functions will help you to prepare healthy, nutritionally balanced meals in half the time you'd expect. Use it to create an amazing range of fresh, tasty and nutrient rich recipes including soups, sauces, doughs, desserts, one-pot meals, smoothies, purees, steamed dishes and much more.

**You can download the Thermocook Pro M 3.0X app by searching for "Cobotmix" in the Apple Store or Google App Store. For detailed instructions and a video tutorial please see page 9.**

For even more inspirational meal ideas, visit our website at [www.froothie.com.au](http://www.froothie.com.au) and our Facebook page at [www.facebook.com/froothie/](https://www.facebook.com/froothie/) to try out new delicious featured recipes.

**You will also find hundreds of free recipes and recipe ideas available online visiting the FroothieTV YouTube channel.**

Lastly, don't forget to **join our Thermocook Adventures Facebook Group** where enthusiasts like yourself share their experiences, tips and recipes for everyone to enjoy.

We are so looking forward to connecting with you there!

<https://www.facebook.com/groups/thermocookadventures/>



**TO ENSURE YOUR SAFETY AND TO GET THE BEST PERFORMANCE FROM YOUR OPTIMUM THERMOCOOK PRO M 3.0X, PLEASE READ THESE INSTRUCTIONS CAREFULLY.**

# SAFETY FIRST



## **BEFORE USING YOUR OPTIMUM THERMOCOOK PRO M 3.0X, PLEASE READ THESE SAFETY INSTRUCTIONS CAREFULLY.**

1. Keep these instructions for use for future reference.
2. Check if the voltage indicated on the appliance corresponds to the local mains voltage before you connect the appliance.
3. Appliances can be dangerous if they are used incorrectly. Please ensure that anyone who uses your Optimum Thermocook clearly understands how to operate it safely to avoid potential hazards.
4. Your Optimum Thermocook is not a toy. Do not allow children to use it; and keep it and the cord that comes with it out of their reach.
5. The cutting blades on your Optimum Thermocook are extremely sharp, and can injure you. Take care when you handle them, e.g. when you empty the bowl or clean it. Do not touch the edge of blades, and be careful to only hold the top part of the blade assembly when you place or remove it.
6. Switch off your Optimum Thermocook and disconnect it from any power supply before you change the accessories or handle any moving parts.
7. Always disconnect your Optimum Thermocook from the power supply if you need to leave it unattended; and before you assemble, disassemble or clean it.
8. Please disconnect your Optimum Thermocook from the power supply when you clean the appliance or put it away for longterm storage.
9. If the supply cord is damaged, it must be replaced by the manufacturer or its service agent in order to avoid a hazard.
10. Accessories, other than those supplied with the appliance, should not be used when operating the Optimum Thermocook. Misuse may damage your appliance and void your warranty.
11. Do not remove the lid while your Optimum Thermocook is boiling water.
12. Do not immerse your Optimum Thermocook in water.
13. Thoroughly clean the parts that will come into contact with food before you use the appliance for the first time.
14. Always put the main appliance on a flat, dry and clean surface.
15. Don't touch the blade especially while they are running. They are very sharp. Only hold the upper part of the blade while removing or re-inserting it.
16. Don't use your attachment and/or appliance if it has been damaged. You should contact an approved service centre.
17. Dropping your Optimum Thermocook or allowing it to fall can seriously damage it. Please place it



# SAFETY FIRST

on a stable, flat, heat-resistant surface (e.g. a bench or table); and ensure that it is at a safe distance from the edge to avoid falling. Please be aware that when you use the unit to knead dough or cut food, vibration may cause it to move; so do not leave it operating unsupervised.

18. Any damage to components – including the main body, bowl, and steamer – can make your Optimum Thermocook less safe to use. Regularly check all components for damage, and if you find something wrong, please stop using the appliance and **contact customer support and our service centre**.
19. If your Optimum Thermocook stops unexpectedly or appears to malfunction, switch off the power supply, unplug it from the mains, and stop using it immediately. Seek professional advice from the manufacturer, its service agent, or a similarly qualified person to identify the fault and make any repairs.
20. The lid cap is the only part that can be safely used to cover the round hole in the bowl lid. Please do not use a cloth or anything similar to cover this hole, and ensure the lid cap is placed correctly to cover it when you process food. Pay attention to the capacity mark on the blender bowl.
21. When processing hot food (for temperature above 60°C), don't touch the lid cap.  
**WARNING**, the lid cap become super hot.
22. When you use the steamer, make sure that it is connected properly to the bowl, and that the steamer lid is in place. Be careful of any vapour that flows out through the top or sides of the cover, as this may scald you. Regularly check that the vent hole on the steamer lid is clear to prevent the vapour from escaping elsewhere.
23. When the steamer is operating, the handles are the only safe place to touch it. Touching it anywhere else may result in injury.
24. After using your Optimum Thermocook, please keep it and any of its parts that are still hot well out of children's reach.
25. Food leakage can damage your Optimum Thermocook. To avoid this, make sure that you place the blade sealing ring correctly onto the blade assembly, and use the fixing bracket to affix the blade assembly to the bottom of the bowl.
26. Poor ventilation can also damage your Optimum Thermocook. To avoid this, ensure that the vents on the back of the main body are clear of any blockages.
27. The appliance is not intended for use by persons (including children) with reduced physical, sensory or mental capabilities, or lack of experience and knowledge, unless they have been given supervision or instruction concerning use of the appliance by a person responsible for their safety. Never let the appliance run unattended.
28. The spatula is only used for moving the food out of the bowl. Don't use it while the blade is running.
29. Be careful when pouring hot liquid into the food processor, as it can be ejected from the appliance due to sudden steaming.
30. When the current temperature of the bowl is at or above 60°C, you will find that the 'high-temperature warning' indicates if the temperature reaches 60°C, a red indicator will appear as a reminder. If the temperature exceeds 60°C, a pop-up window reminder will appear. Additionally, whenever the machine is set to a temperature, it will limit the speed to 1-4 as long as the temperature exceeds 60°C.
31. Ensure you do not surpass the maximum fill level indicated inside the bowl.
32. Exercise caution when handling any part of the appliance during or after use in cooking mode. Pay special attention to the bowl, lid, and tools, as they may retain heat for an extended period after the appliance has been turned off.
33. Utilize the handles for lifting and transporting the bowl. Always wear oven gloves when handling the hot bowl and tools.

# SAFETY FIRST

34. The underside of the bowl will retain heat for a significant duration after heating ceases. Exercise caution when handling and utilize a heat-resistant surface protection mat when placing the bowl on surfaces sensitive to heat.
35. Always close the lid cap when using the chopping function.
36. Never operate the appliance in the cook mode with the bowl empty.
37. Avoid using the bowl lid instead of the food processor lid to operate the food processor. Doing so may damage the appliance and could potentially lead to injury if excessive force is applied to the interlock mechanism.
38. For the correct and safe operation ensure that the bowl base and temperature sensors are clean and dry before cooking.
39. **CAUTION:** To prevent the inadvertent resetting of the thermal cut-out and potential hazards, avoid supplying power to this appliance through an external switching device, such as a timer, or connecting it to a circuit that is frequently switched on and off by the utility.
40. Always ensure that food is cooked thoroughly and piping hot before consumption.
41. Food should be consumed promptly after cooking or rapidly cooled and refrigerated as soon as possible.
42. The maximum load for the blending function is 1200 grams of carrots or 1800 grams of water.
43. The appliance is only to be used with the stand (motor base) provided.
44. This appliance is intended for indoor household use only.
45. Prevent spillage on the connector (motor base) to avoid damage.
46. Do not dismantle the base of the cup, including the handle enclosure, as it is not intended for user maintenance.
47. After the motor stops operating, if it was running, the cooling fan will continue to operate for an additional 2 minutes.
48. Surfaces may become hot during use. 
49. Please ensure that the machine is connected to the WIFI network to receive recipes and software upgrade notifications promptly. Failure to connect to the network will result in the inability to receive recipes and software upgrade notifications.
50. **CAUTION:** Ensure the appliance is switched off before removing the bowl from the motor base.
51. Before plugging in, ensure that your electricity supply matches the specifications indicated on the underside of your appliance.
52. **WARNING: THIS APPLIANCE MUST BE EARTHED.**

**IMPORTANT: FAILURE TO FOLLOW THESE SAFETY INSTRUCTIONS AND WARNINGS COULD RESULT IN SERIOUS INJURY. ADDITIONALLY, MISUSING YOUR OPTIMUM THERMOCOOK PRO M 3.OX MAY DAMAGE IT AND VOID YOUR WARRANTY.**

# GETTING TO KNOW YOUR THERMOCOOK PRO M 3.0X PARTS

This section introduces you to the key components of your new Optimum ThermoCook Pro M 3.0X.

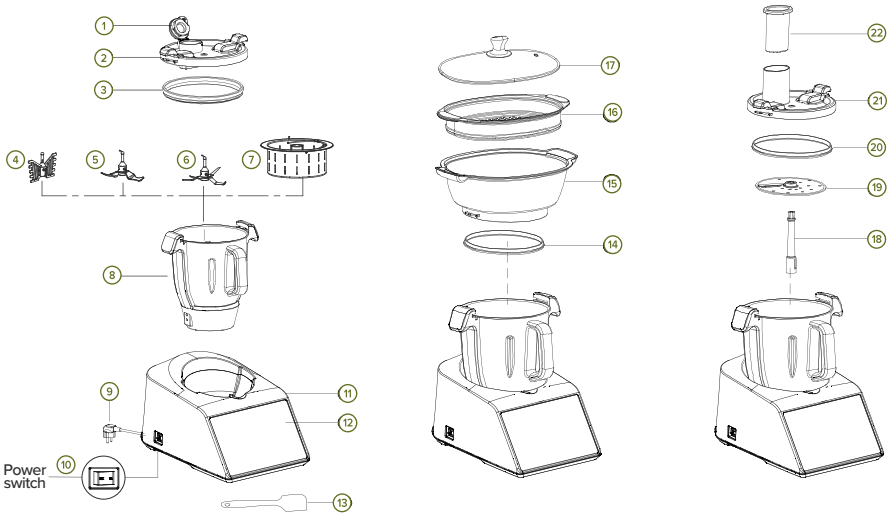
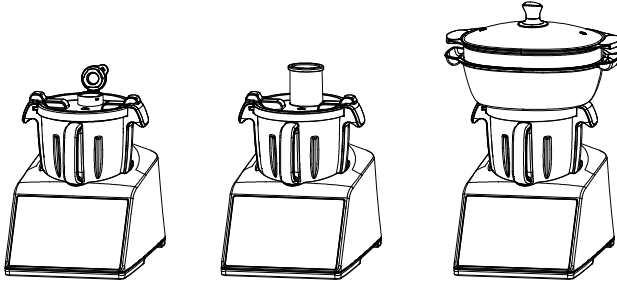

## PART NAMES:

1	Lid cap	8	Bowl	15	Large steamer basket	22	Pusher
2	Bowl lid	9	Power cord	16	Shallow steamer basket		
3	Bowl lid sealing ring	10	Power switch	17	Steamer basket lid		
4	Butterfly whisk	11	Motor base	18	Drive shaft		
5	Stirring attachment / Paddle	12	10" digital display screen	19	Slicer / Shredder plate		
6	Stainless steel blade	13	Spatula	20	Food processor lid sealing ring		
7	Small steaming basket	14	Large steamer basket sealing ring	21	Food processor lid		

# GETTING TO KNOW YOUR THERMOCOOK PRO M 3.0X DIGITAL DISPLAY / CONTROL PANEL

## Home Screen - Menu

27	Automatic Recipes
28	Automatic Programs
29	Manual Cooking
30	Download New Recipes



## Automatic Recipes Interface

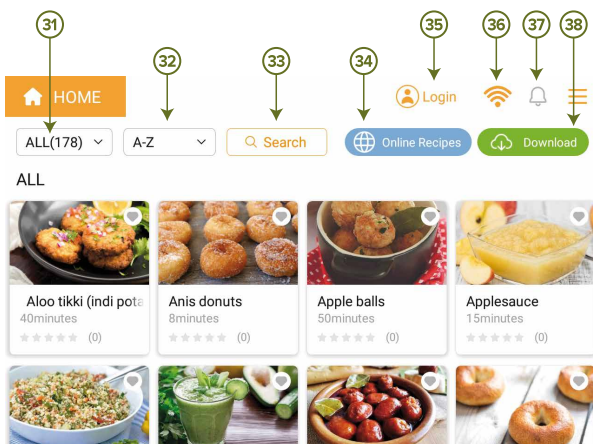

31	Recipes Classification
32	Recipes Sorting
33	Recipe Search
34	Online Recipes
35	User Account / Login
36	WiFi
37	Notifications
38	Download Recipes

# GETTING TO KNOW YOUR THERMOCOOK PRO M 3.0 DIGITAL DISPLAY / CONTROL PANEL

## Manual Cooking Interface

The diagram illustrates the manual cooking interface on the Thermocook Pro M 3.0. It features a digital display showing a recipe for 'Aloo tikki (Jndi potato croquettes)' with a temperature of 0°C. The interface includes several control buttons and settings:

- 39** Weight: Located at the top right of the display.
- 40** Turbo Button: Located at the top right of the display.
- 41** Temperature Setting: A red button labeled 'TEMPERATURE' showing '-0°C' and '0°C'.
- 42** Reset To Default Setting: A white button labeled 'RESET'.
- 43** Time Setting: A white button labeled 'TIME' showing '-00:05' and '00:00'.
- 44** Speed Setting: A white button labeled 'SPEED' showing '5'.
- 45** Start Button: A large orange button labeled 'START'.
- 46** Steering Setting: A white button labeled 'DIRECTION' showing 'TURN RIGHT'.
- 47** Reverse: A circular control with 'TURN LEFT' and 'TURN RIGHT' options.
- 48** Clockwise: A circular control with 'TURN LEFT' and 'TURN RIGHT' options.

39	Weight
40	Turbo Button

41	Temperature Setting	45	Start Button
42	Reset To Default Setting	46	Steering Setting
43	Time Setting	47	Reverse
44	Speed Setting	48	Clockwise

## Automatic Programs Interface

The Automatic Programs Interface features a navigation bar with a 'HOME' button and icons for 'Login', Wi-Fi, and notifications. Below the navigation bar are three program options:

- BOIL WATER**: Represented by an image of a glass teapot.
- CHOP**: Represented by an image of chopped vegetables.
- SLOW COOK**: Represented by an image of slow-cooked meat.

# GETTING TO KNOW YOUR THERMOCOOK PRO M 3.0X DIGITAL DISPLAY / CONTROL PANEL

## Setup / Settings

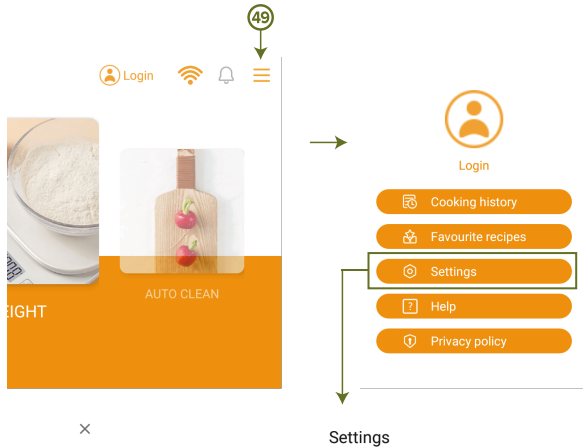

49	Settings
50	Software Updating
51	Android System Updating
52	Recipes Updating

×

### Settings



×

### About

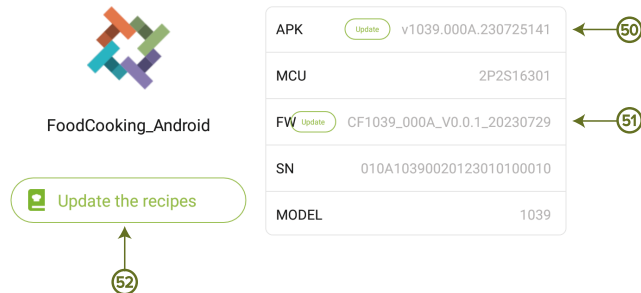

# GETTING TO KNOW YOUR THERMOCOOK PRO M 3.0X

## CONNECT TO WIFI / APP

You can download the Thermocook Pro M 3.0X app by searching for "Cobotmix" in the Apple Store or Google App Store.

### Need help connecting your ThermoCook to the app?

For additional written instructions, see below the video. Or, watch our easy-to-follow video guide at <https://youtu.be/D9-MPJEWPKw?si=TCjvbatrkHFQ4HdO> or scan the QR code below.



### Instructions

1. If you're using an Apple or Android device, just search for "Cobotmix" in the App Store or Google Play Store.
2. Download the app and wait for it to install.
3. Once it's ready, open the app and hit "Sign Up." You can use your email or phone number—whichever you prefer—and pick a good password.
4. Now, let's get your Thermocook device connected. Head to "Settings," then "User Account," and tap "Sign Up."
5. Use the same email or phone number you used on the app to keep things simple.
6. After that, go back to "Settings" and tap the Wi-Fi icon to connect your device to your Wi-Fi network. Just make sure your phone is connected to the same Wi-Fi.
7. Go to the settings on your Thermocook and click the app icon to prepare it for connection.
8. On your phone, open the Cobotmix app and tap the bracket and dash symbol in the top-right corner. After a few seconds, the Thermocook will appear—select it to connect.
9. Once you're all set, your Thermocook will be online, giving you access to 1,000+ recipes and full control of the device from your phone.

Just a heads up—for security reasons, you can stop or pause cooking from your phone, but you can't start it.

Now, go ahead and enjoy all the awesome features!

# GETTING TO KNOW YOUR THERMOCOOK PRO M 3.0X USER ACCOUNT

## User Registration & Log In



[HOME >>](#)

Not a **member** yet?

Join us today and enjoy the ultimate cooking experiences with recipes, updates and more!

[Login / Sign up](#)

[Skip for now](#)

## User Registration



[HOME >>](#)

Sign up, it's FREE

Composed of letters and numbers, with no less than 8 digits.

[Register](#)

[Login](#)



# GETTING TO KNOW YOUR THERMOCOOK PRO M 3.0X USER ACCOUNT

## User Log In



[HOME >>](#)

Login

[Forgotten password](#)

Login

[Register](#)

## Reset Password



[HOME >>](#)

Reset Password

[Send Email](#)

[Enter the Captcha obtained from the mail](#)

Reset Password

[Login](#)

# OPERATING INSTRUCTIONS

- 1 Place the motor base on a flat, sturdy surface. Ensure the surface is clean and dry.

2

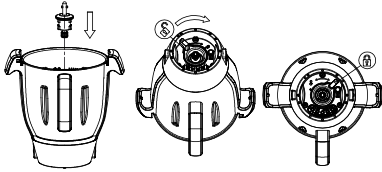

Ensure the blade assembly base is correctly inserted and securely locked to the bowl with the blade assembly nut.

3

Place the bowl on the motor base, ensuring the handle is pointing to the front. Press down firmly to lock the bowl into place.

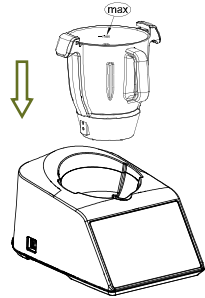

4

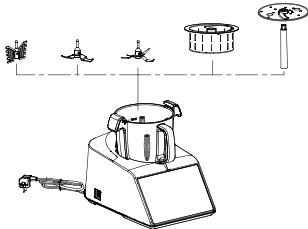

Attach any additional accessories for your recipe

5

Add ingredients or water to the bowl. If using the food processor function, add ingredients directly through the food processor lid.

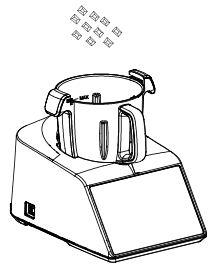

6

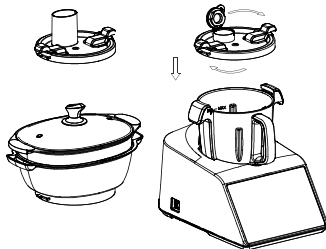

Attach bowl lid, food processor lid or steamer for your recipe.

7

Once lid or steamer is attached, plug the power cord into an electrical outlet. Switch on the Thermocook at the main power switch and select your recipe or function to start cooking.

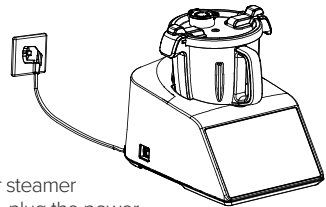

**IMPORTANT:** Please note, in order to turn the unit on, there is an on/off switch located on the lower left-hand side of the machine.

# OPERATING INSTRUCTIONS

8

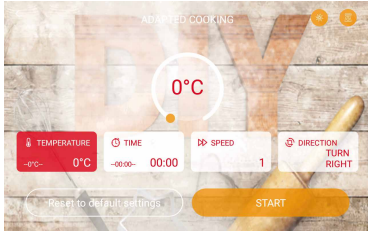

Press the temperature, time, speed and direction icons to adjust settings. To quickly set exact times, press on the minute or second time icons. For reverse function, press the reverse function icon.

9

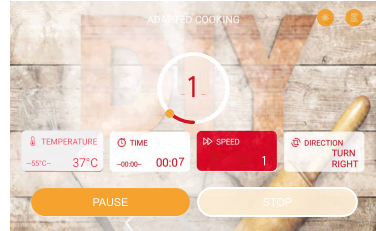

Temperature, time, speed and direction icons highlight in red can be adjusted by turning the dial until you reach your setting. To clear current settings, press STOP and then press RESET.

Press PAUSE to pause the machine from running. Press RESUME to start the machine again. Press STOP to return to the home screen. Whenever changing the temperature, time or speed whilst the Thermocook is in operation, you will have confirm your changes by clicking RESUME.

10



Once cooking is completed and the function has finished, the screen will show END.

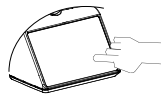

11

**IMPORTANT:** To lift the jug off the base, please ensure the lid is open. Then, use both handles at the top of the bowl and both hands, to lift the jug directly upwards from the base.

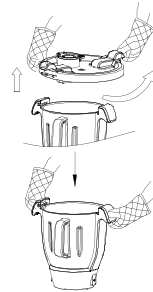

12

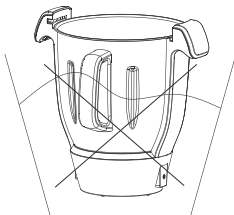

The Thermocook bowl can be cleaned with warm soapy water but do not immerse the bowl in water. Avoid putting the bowl into the dishwasher.

# OPERATING INSTRUCTIONS

13

Accessories that can be put in the dishwasher include the cooking lid, food processor attachment, large steamer basket, small steaming basket, stirring paddle attachment, butterfly whisk, and spatula.

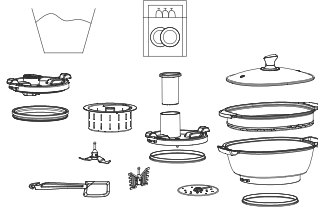

14

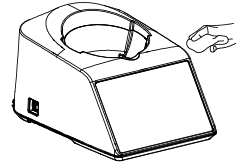

Wipe the Thermocook base with a soft damp cloth.

## NOTE:







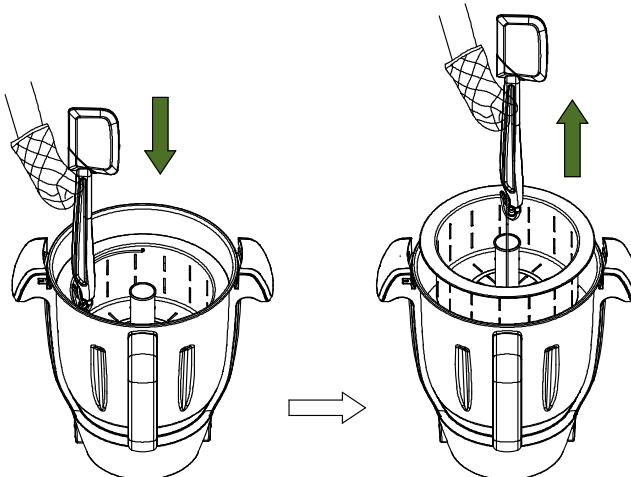

To remove the small steaming basket safely, follow these steps:

- Put on oven gloves for protection.
- Use the hook on the handle of the spatula to wrap around the middle of the steam basket handle.
- Lift the steam basket up with care.









**Note:** Wait until the steam has cleared before handling to prevent burns.



# CONTROL PANEL OVERVIEW

	Icon	Function description
1		Back Button: Press this icon at any time to return to the previous menu.
2		Set time display Working time display: 0-90 minutes for manual mode. Up to 8 hours in slow cooking programs. Press TIME to select.
2.1		Press your finger on the numbers to set value. You can also use the "+" and "-" icons to adjust time. When the time is not set, it will show the working time after starting. When setting the time, the remaining time will be displayed after starting the Thermocook.
2.2		The digit within the red box indicates the set time.
2.3		When the time is not set, the digit in the red box indicates the working time. When setting the time, the remaining time will be indicated in the red box.
3		Set temperature display Temperature range: 37°C-130°C. After 40°C temperature increases by 5°C increments. Press TEMPERATURE to select.
3.1		The digit within the red box indicates the temperature setting.
3.2		Current bowl temperature: After 40°C temperature increases by 5°C increments.











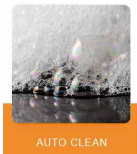

# CONTROL PANEL OVERVIEW

	Icon	Function description
3.3		Adjust temperature by sliding the disk with your finger. Use the "+" and "-" buttons to adjust the temperature. The actual temperature in the bowl will be displayed after starting.
4		Set speed display Clockwise speed ranges between 0-12. Reverse speed ranges between 0-3. Press SPEED to select.
4.1		Adjust the speed by pressing and sliding the disc with your finger.
4.2		Direction button used to change blade direction to forward (clockwise) or reverse (anti-clockwise).
4.3		Forward (clockwise)
4.4		Reverse (anti-clockwise)
4.5		This icon indicates a safety feature related to opening the lid. For safety reasons, the lid cannot be opened during cooking. When you press the "Pause" button, a 5-second countdown will appear in the top right corner of the screen, after which the lid can be opened. <b>Please exercise caution when opening, as hot steam may escape.</b>
5.1		Auto Programs Time range: 0-90 minutes, Temperature range: 0°C-130°C, Forward (clockwise) speed range: 0-12, Reverse (anti-clockwise) speed range: 0-3. Maximum working times for speeds 7-12 is 10 minutes.
5.2		Weighing function Maximum weight: 5kg, Increments: 1g

# CONTROL PANEL OVERVIEW











	Icon	Function description
5.21		Tare to reset scales
5.3		Boil Water Function Temperature: 100°C Speed: 1 (forward range 0-1 or reverse range 0-1) Ends function after reaching the preset water temperature.
5.4		Chop Function Temperature: 0°C Time: 10 seconds (range 0-4 minutes) Speed: 6 (forward range 1-12)
5.5		Slow Cook Function Temperature: 90°C (range 37°C-95°C) Time: 4 hours (range 0-8 hours) Speed: 1 (forward) or 1 (reverse) Heats to the preset temperature before time starts counting down.
5.6		Knead Dough Function Temperature: 0°C (range 0°C-37°C) Time: 3 minutes (range 2-4 minutes) Speed: 3 (range 1-3)
5.7		Steam Function Temperature: 120°C (range 100°C-120°C) Time: 20 minutes (range 1-60 minutes) Speed: 0 (forward range 0-3 or reverse range 0-3) Time starts counting down from 95°C.
5.8		Food Processor Function Time: 30 seconds (range 10-60 seconds) Speed: 5 (range 4-6)

# CONTROL PANEL OVERVIEW







	Icon	Function description
5.9		Turbo Function Press  and hold for 3 seconds for blades to spin at high speed. Release button to stop blades spinning.
5.10		Auto clean
6		Press this icon at any time to return the home screen.
7		Settings button
7.1		Settings Press to change Thermocook settings. Check system information including WIFI, versions, language and more.
7.2		Cooking History Review all previous recipes.
7.3		Favorite Recipes Browse through your personal collection of selected recipes.
7.4		Privacy Policy
8.1		Ingredients
8.2		Cooking steps
8.3		Chef's tips
8.4		Check recipe information



# CONTROL PANEL OVERVIEW

	Icon	Function description
8.5		There are the following functions: Recipes comments, Share recipes, delete recipes
8.51	 Score	Recipe comments
8.52	 Share	Share recipe
8.53	 Delete	Delete recipe
8.9		Favourite recipe
8.10		Unsave recipe
8.11		Hide recipe rating, preparation time, difficulty level
8.12		Display recipe rating, preparation time, difficulty level
8.13		Exit
8.14		Recipe notes

# PROCESSING GUIDE / SUGGESTED USAGE OF ATTACHMENTS

Part / Attachment		Function	Speed	Time	Temperature °C	Maximum cooking ingredients in one batch
	<b>Butterfly whisk</b>	Whip egg white	4	2 - 4 minutes	-	2 - 4 egg white
		Whip cream	3	3 - 5 minutes	-	200ml
	<b>Stirring attachment / Paddle</b>	Soup	1 - 2	1 - 90 minutes	100 °C	Maximum Capacity: 2000ml
		Other ingredients requiring heating	1 - 2	As required	As required	
	<b>Blade</b>	Meat chopping	8 - 12	30 - 60 seconds	-	1500g beef / pork (boneless)
		Ice crushing	8 - 12	10 - 20 seconds	-	300g ice cube
		Blender	8 - 12	1 - 2 minutes	-	Maximum capacity: 3000ml: 1200g carrot 1800g water
		Chopping (onion, shallot, celery, etc)	5 - 7	15 - 60 seconds	-	300g
		Bean, soybean, nut, peanut, coffee beans, almonds, etc	12	2 - 3 minutes	-	200g
		Kneading	2 - 3	2 - 3 min	-	500g flour + 250ml water + 20ml oil
	<b>Small steaming basket</b>	Rice, grains and eggs	-	20 - 30 minutes	Steam program: Low / med temperature	600 - 1500ml water
	<b>Slicer / Shredder plate</b>	Slices, shreds (Carrot, cucumber, potato)	5 - 6	30 - 60 seconds	Only Food processor program	500g
	<b>Large steamer basket</b>	Fish, poultry, vegetables, baby foods and desserts	-	10 - 60 minutes	Steam program: Low / med temperature	600 - 1500ml water

# ESSENTIAL SETTINGS / QUICK REFERENCE

This Quick Reference Guide is designed to **help you make the most of your Thermocook** by providing all the time, speed and temperature settings for the most common kitchen tasks such as grating, chopping, milling, cooking and steaming for a variety of ingredients.

Whether you are preparing a simple meal or experimenting with new recipes, **this guide will ensure you achieve perfect results every time.**

Use it as your go-to resource for quick and easy settings, allowing you to save time and bring out the best flavours in all your dishes.

Let's get cooking with confidence!

## YOU'LL NEED THE FOLLOWING ATTACHMENTS

<b>Multifunction blades</b>	Designed for a variety of tasks, from chopping and slicing to blending and mixing. These blades are made to handle both soft and hard ingredients.
<b>Stirring / Kneading blades</b>	Ideal for stirring sauces, sautéing and kneading dough. It provides precise control and thorough mixing, ensuring your recipes turn out perfectly every time.
<b>Butterfly whisk</b>	Perfect for whipping cream, beating eggs, and creating light, airy mixtures. Its unique shape ensures even aeration and smooth, consistent results.
<b>Inner basket</b>	Useful for cooking or steaming ingredients separately from those being prepared in the main bowl. It can also be used to rinse grains or strain ingredients.
<b>Steamer and tray</b>	Designed to fit on top of the mixing bowl, this steamer and tray allows for healthy steaming of vegetables, fruits, fish and meats, enabling you to cook multiple components of your meal simultaneously.
<b>Slicer attachment</b>	Slice vegetables, fruits and cheese for salads, garnishes and any dish needing evenly sliced ingredients.
<b>Grater attachment</b>	Achieves coarse grating with ease. Perfect for quickly grating cheese, vegetables, and other ingredients, adding flavour to your favourite dishes.

# ESSENTIAL SETTINGS / QUICK REFERENCE

## GRATING, CHOPPING AND MILLING

Below are the recommended Thermocook speeds and times for grating, chopping and milling. These settings are tailored for the best results for each ingredient and can be used in a wide range of recipes.

### GRATING

INGREDIENTS	TIME / SPEED	ATTACHMENT
Apples - cut into quarters	Speed 12	Grater attachment
Cabbage - roughly chopped	Speed 12	Grater attachment
Carrots	Speed 10	Grater attachment
Cheese - medium-hard	Speed 10	Grater attachment
Cheese - parmesan, cut into 3cm pieces	Speed 12	Grater attachment
Chocolate	Speed 10	Grater attachment
Cucumbers	Speed 12	Grater attachment
Pears, nectarines, apricots - drupe removed	Speed 12	Grater attachment
Zucchini	Speed 10	Grater attachment

# ESSENTIAL SETTINGS / QUICK REFERENCE

## GRATING

INGREDIENTS	QUANTITY	TIME / SPEED	ATTACHMENT
Apples - cut into quarters	100g - 400g	3 sec / speed 6	Multifunction blades
Breadcrumbs - bread cut into 3cm pieces	200g	8 sec / speed 7	Multifunction blades
Cabbage - roughly chopped	300g - 600g	8 sec / speed 7	Multifunction blades
Carrots	200g - 400g	6 sec / speed 7	Multifunction blades
Cheese - medium-hard and cut into 3cm pieces	80g - 300g	10 sec / speed 9	Multifunction blades
Cheese - parmesan, cut into 3cm pieces	80g - 300g	10 sec / speed 9	Multifunction blades
Chocolate - dark and coarsely grated	200g - 350g	5 sec / speed 9	Multifunction blades
Chocolate - milk and coarsely grated	200g - 350g	5 sec / speed 8	Multifunction blades
Chocolate - white and coarsely grated	200g - 350g	5 sec / speed 9	Multifunction blades
Pears, nectarines, apricots - drupe removed	180g - 400g	5 sec / speed 6	Multifunction blades
Potatoes - peeled and cut into pieces	200g - 800g	8 sec / speed 6	Multifunction blades
Plums - drupe removed	180g - 400g	5 sec / speed 7	Multifunction blades

# ESSENTIAL SETTINGS / QUICK REFERENCE

## CHOPPING

INGREDIENTS	QUANTITY	TIME / SPEED	ATTACHMENT
Beef - sinew-free, partially frozen and cut in 4cm pieces	250g - 400g	8 sec / speed 10	Multifunction blades
	400g - 500g	12 sec / speed 10	Multifunction blades
Garlic	1 clove	3 sec / speed 7	Multifunction blades
	30g - 70g	3 sec / speed 6	Multifunction blades
	120g - 200g	5 sec / speed 8	Multifunction blades
Hazelnuts or almonds - coarsely chopped	100g - 150g	4 sec / speed 7	Multifunction blades
	150g - 350g	6 sec / speed 7	Multifunction blades
Herbs - fresh and leaves only	15g -30g	3 sec / speed 6	Multifunction blades
	30g - 45g	4 sec / speed 6	Multifunction blades
	45g - 80g	6 sec / speed 7	Multifunction blades
Ice - crushed	150g - 500g	6 sec / speed 5	Multifunction blades
Lamb - sinew-free, partially frozen and cut in 4cm pieces	250g - 400g	12 sec / speed 9	Multifunction blades
Onion - cut in half	20g - 100g	3 sec / speed 7	Multifunction blades
	100g - 500g	6 sec / speed 7	Multifunction blades
	600g	6 sec / speed 8	Multifunction blades
Peanuts, cashews, walnuts and pecans - coarsely chopped	80g - 180g	5 sec / speed 7	Multifunction blades
	180g - 400g	6 sec / speed 6	Multifunction blades
Pork - sinew-free, partially frozen and cut in 4cm pieces	250g - 350g	10 sec / speed 8	Multifunction blades
	400g - 500g	15 sec / speed 8	Multifunction blades
Poultry - partially frozen and chopped into 4 cm pieces	250g - 350g	6 sec / speed 8	Multifunction blades
	400g - 500g	8 sec / speed 9	Multifunction blades

# ESSENTIAL SETTINGS / QUICK REFERENCE

## MILLING

INGREDIENTS	QUANTITY	TIME / SPEED	ATTACHMENT
Coffee beans	80g - 400g	40 sec / speed 12	Multifunction blades
Dried pulses - chickpeas	100g - 500g	50 sec / speed 12	Multifunction blades
Grains	80g - 400g	1 min / speed 12	Multifunction blades
Nuts	100g - 400g	10 sec / speed 9	Multifunction blades
Poppy seeds	80g - 400g	40 sec / speed 10	Multifunction blades
Rice	80g - 300g	2 min / speed 10	Multifunction blades
Sesame seeds	80g - 300g	16 sec / speed 12	Multifunction blades
Spices	20g - 300g	50 sec / speed 10	Multifunction blades
Sugar - white and brown	100g - 400g	18 sec / speed 12	Multifunction blades

# ESSENTIAL SETTINGS / QUICK REFERENCE

## COOKING

Explore the Thermocook's cooking settings for boiling, sauteing, chopping, slow cooking, kneading, and simmering. Each setting provides the speeds, times and temperatures for optimal results in all your meals.

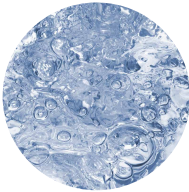

**Boiling:** To achieve boiling, ensure there is sufficient liquid or water in the bowl, then set the temperature to 100°C and speed to reverse 1 for 9 minutes.



**Simmering:** For gentle cooking and simmering of ingredients, set the temperature to 95°C which is just below boiling and set speed to reverse 1 for your desired time. This allows for a gentle simmer, ensuring your ingredients cook evenly and retain their flavour.



**Sautéing:** To sauté ingredients directly in the bowl, set the temperature to 120°C and set speed to reverse 1. Allow the ingredients to sauté for 5-10 minutes for optimal flavour infusion.



**Chopping:** For precise and efficient chopping, add your ingredients to the bowl, then set the speed to 5-7 depending on the desired coarseness. Pulse for a few seconds at a time until the ingredients reach the desired consistency. The powerful blades ensure uniform cuts, making prep work quick and easy.



**Kneading:** To knead dough effortlessly, use the kneading function by setting the speed to 2-4 and running the appliance for 3 minutes. This setting mimics the traditional kneading process, ensuring your dough is smooth and elastic, ready for baking.



# ESSENTIAL SETTINGS / QUICK REFERENCE

## STEAMING

Discover the best settings for steaming vegetables, fruits, fish, and meats with the Thermocook. Each ingredient goes through the temperatures, times and speeds for achieving the perfect results.



- Remember to fill the bowl with water and use the steamer and tray or inner basket.
- When steaming for extended times, consider adding extra water to the bowl.
- Make sure the holes in the steamer tray aren't covered so the steam can circulate freely.

### STEAMING VEGETABLES

INGREDIENTS	QUANTITY	TIME / SPEED / TEMP	ATTACHMENT
Artichoke hearts	500g - 900g	34 min / speed 2 / 120°C	Steamer and tray
Asparagus	200g - 750g	20 min / speed 2 / 120°C	Steamer and tray
Beetroots - quartered	300g - 800g	60 min / speed 2 / 120°C	Steamer and tray
Bell pepper - cut or sliced	80g - 250g	14 min / speed 1 / 120°C	Inner basket
	300g - 800g	16 min / speed 2 / 120°C	Steamer and tray
Broccoli florets	100g - 250g	12 min / speed 1 / 120°C	Inner basket
	300g - 750g	18 min / speed 2 / 120°C	Steamer and tray
Brussel sprouts	200g - 600g	28 min / speed 2 / 120°C	Steamer and tray
Carrots - sliced	100g - 450g	22 min / speed 1 / 120°C	Inner basket
	500g - 750g	26 min / speed 2 / 120°C	Steamer and tray
Cauliflower florets	250g	18 min / speed 1 / 120°C	Inner basket
	300g - 800g	22 min / speed 2 / 120°C	Steamer and tray
Celery	180g - 350g	22 min / speed 1 / 120°C	Inner basket
	400g - 750g	26 min / speed 2 / 120°C	Steamer and tray
Corn - on the cob	250g - 900g	26 min / speed 2 / 120°C	Steamer and tray
Eggplant - medium-sized	250g - 750g	16 min / speed 2 / 120°C	Steamer and tray
Fennel - quartered	180g - 450g	22 min / speed 1 / 120°C	Inner basket
	500g - 850g	28 min / speed 2 / 120°C	Steamer and tray
Fresh green beans - cut into pieces	180g - 250g	18 min / speed 1 / 120°C	Inner basket
	300g - 750g	24 min / speed 2 / 120°C	Steamer and tray
Leeks	180g - 350g	20 min / speed 1 / 120°C	Inner basket
	400g - 750g	24 min / speed 2 / 120°C	Steamer and tray
Mushrooms - whole	80g - 250g	14 min / speed 1 / 120°C	Inner basket
	300g - 800g	16 min / speed 2 / 120°C	Steamer and tray
Peas - frozen	180g - 450g	16 min / speed 1 / 120°C	Inner basket
	400g - 750g	20 min / speed 2 / 120°C	Steamer and tray
Potatoes and sweet potatoes	180g - 500g	25 min / speed 1 / 120°C	Inner basket
	550g - 900g	28 min / speed 2 / 120°C	Steamer and tray
Pumpkin - chopped into 3cm pieces	250g - 900g	30 min / speed 2 / 120°C	Steamer and tray
Spinach - fresh	500g	12 min / speed 2 / 120°C	Steamer and tray
Zucchini - sliced	180g - 450g	16 min / speed 1 / 120°C	Inner basket
	500g - 850g	22 min / speed 2 / 120°C	Steamer and tray

# ESSENTIAL SETTINGS / QUICK REFERENCE

## STEAMING FRUITS

INGREDIENTS	QUANTITY	TIME / SPEED / TEMP	ATTACHMENT
Apple - quartered	180g – 450g	20 min / speed 1 / 120°C	Inner basket
	500g - 650g	22 min / speed 2 / 120°C	Steamer and tray
Apricot and peach - halved	250g - 350g	12 min / speed 1 / 120°C	Inner basket
	400g - 750g	14 min / speed 2 / 120°C	Steamer and tray
Pear - peeled and quartered	180g – 450g	14 min / speed 1 / 120°C	Inner basket
	500g - 750g	18 min / speed 2 / 120°C	Steamer and tray
Pineapple - peeled, cored and cut into thin pieces	180g – 450g	16 min / speed 1 / 120°C	Inner basket
	500g - 650g	22 min / speed 2 / 120°C	Steamer and tray
Plum - halved	180g – 350g	12 min / speed 1 / 120°C	Inner basket
	400g - 650g	14 min / speed 2 / 120°C	Steamer and tray

## STEAMING FISH

INGREDIENTS	QUANTITY	TIME / SPEED / TEMP	ATTACHMENT
Clams	300g - 800g	17 min / speed 2 / 120°C	Steamer and tray
Fish fillets - salmon, sea bass and snapper	2 - 6 fillets 120g -180g each	16 min / speed 2 / 120°C	Steamer and tray
Mussels	400g	14 min / speed 1 / 120°C	Steamer and tray
	900g	17 min / speed 2 / 120°C	Steamer and tray
Raw prawns - peeled	300g - 800g	14 min / speed 2 / 120°C	Steamer and tray
Raw prawns - unpeeled, large prawns, shell and head on	300g - 800g	16 min / speed 2 / 120°C	Steamer and tray
Scallops	400g	16 min / speed 1 / 120°C	Steamer and tray
	900g	19 min / speed 2 / 120°C	Steamer and tray
Whole fish - barramundi, trout and snapper	2 (450g each)	16 min / speed 1 / 120°C	Steamer and tray
	4 (450g each)	19 min / speed 2 / 120°C	Steamer and tray

## STEAMING MEAT

INGREDIENTS	QUANTITY	TIME / SPEED / TEMP	ATTACHMENT
Beef fillet	450g - 600g	26 min / speed 1 / 120°C	Steamer and tray
Chicken breasts	500g	20 min / speed 1 / 120°C	Steamer and tray
	600g - 900g	24 min / speed 2 / 120°C	Steamer and tray
Chicken thigh fillets	250g - 900g	24 min / speed 1 / 120°C	Steamer and tray
Lamb cutlets	400g - 800g	18 min / speed 2 / 120°C	Steamer and tray
Meatballs	450g - 600g	22 min / speed 1 / 120°C	Steamer and tray
	650g - 1000g	26 min / speed 1 / 120°C	Steamer and tray
Pork tenderloin	400g - 1400g	32 min / speed 1 / 120°C	Steamer and tray

# CLEANING AND MAINTENANCE

1. Before cleaning the appliance, switch off the Thermocook and remove the power cord plug from the power point.
2. Wipe the Thermocook base with a soft damp cloth.
3. Only use a soft dry cloth to clean the power cord.
4. Remove the lid and any attachments including the blade assembly.

## IMPORTANT

The blade assembly is very sharp, please ensure to handle it with care.

5. Clean the bowl by hand with warm soapy water. You can also use the “Auto Clean” Program.
6. Clean all parts immediately after use with warm soapy water then dry thoroughly:
  - a. The following parts can be cleaned in the top rack of the dishwasher: Cooking lid, food processor attachment, large steamer basket, small steaming basket, stirring paddle attachment, butterfly whisk, and spatula.

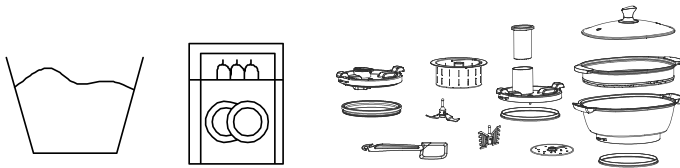

- b. Then fill the bowl with warm soapy water and allow it to soak. Remove any stubborn deposits using a cleaning brush. Any discolouration of the bowl will not affect the performance of the appliance. When there are burn marks on the bottom of the bowl, add some vinegar or lemon to water and heat for 5-7 minutes, then remove the burn marks with a soft dish cloth.

## DEEP CLEANING

### The Mixing Bowl

- ▶ **Initial Rinse:** Empty any leftovers and rinse the bowl with warm water to remove loose particles.
- ▶ **Soapy Water:** Fill the bowl with warm water and add a few drops of dish soap. Run the machine for 30 sec / speed 10 to let the soapy water clean the blades and interior.
- ▶ **Scrub if Needed:** For stubborn residue, use a non-abrasive sponge or brush to gently scrub the inside of the bowl. Avoid harsh scrubbing pads that can scratch the surface.
- ▶ **Rinse and Dry:** Thoroughly rinse the bowl with clean water and dry it with a clean towel or let it air dry.

# CLEANING AND MAINTENANCE

## **The Base and Touch Screen**

- ▶ **Wipe Down:** Use a soft, slightly damp cloth to wipe down the base and touch screen. Avoid spraying any cleaning agents directly onto the base. Instead, apply a mild cleaner to the cloth if needed.
- ▶ **Avoid Moisture:** Ensure that no water seeps into the electrical components. Keep the cleaning cloth only lightly damp.

## **The Accessories (Steaming Basket, Blades, Lid, Measuring Cup)**

- ▶ **Disassemble and Soak:** Remove all detachable parts and soak them in hot soapy water for a few minutes.
- ▶ **Scrub Each Part:** Use a dish brush or sponge to clean each part thoroughly, paying special attention to areas where food residue can accumulate.
- ▶ **Rinse and Dry:** After scrubbing, rinse all parts with clean water and dry them thoroughly before reassembling.

## **For stains at the bottom of the bowl**

- ▶ Add 2 tablespoons of bicarbonate of soda, 1 tablespoons of white vinegar and enough water to cover the blades.
- ▶ Start your machine for 3 min / 100°C / speed 3. Then rinse with clean water and it's ready to go.

## **IMPORTANT**

- Never use pointed or sharp objects for cleaning as this may damage parts or affect the safety of the appliance.
- Never leave the blade assembly soaking for extended periods of time as this may damage the bearings.
- Never use harsh cleaning agents such as metal brushes, nylon brushes, household cleaners or diluents, as they may damage the surface and structure of the parts. Use gentle cleaning products only.
- Always keep the contact pins on the bottom of the bowl clean and dry before putting the bowl back on to the base.

7. Reattach the clean blade assembly to the bowl.

**NOTE:** Check seals and gaskets around the lid and blades for wear and tear. Replace them if they show signs of deterioration to maintain the appliance's efficiency and safety.

# TROUBLESHOOTING

Problem	Potential cause	Solution
<b>Cannot be powered on</b>	<p>Machine not properly plugged into the power source.</p> <p>The temperature of the motor is too high, triggering overheat protection.</p>	<ol style="list-style-type: none"> <li>1. Check that the machine is plugged into the wall and the power point is on.</li> <li>2. If the machine is plugged in and the power point is on, switch it off.</li> <li>3. Wait for 1 hour, then restart the appliance.</li> <li>4. If the appliance still doesn't work after restarting, it needs to be sent to the approved service centre for further assessment and repair.</li> </ol>
<b>Motor overload or abnormal operation</b>	<p>The temperature of the motor is too high, triggering overheat protection.</p>	<p>Firstly power off, and then restart the appliance after 1 hour. It needs to be sent to the approved service centre if it still doesn't work.</p>
<b>Weighing unavailable or abnormal</b>	<p>Incorrect placement of ingredients or accessories on the weighing scale.</p>	<ol style="list-style-type: none"> <li>1. Ensure ingredients or accessories are placed correctly on the weighing scale.</li> <li>2. Check for any visible damage to the weighing scale or associated components; if found, contact customer support.</li> <li>3. Restart the appliance or perform a software reset to address any software malfunctions affecting the weighing function. If the issue persists, contact customer support for further assistance.</li> </ol>
<b>No bowl detected</b>	<p>Bowl not properly inserted or recognized by the appliance. The bowl is dirty on the underside.</p>	<ol style="list-style-type: none"> <li>1. Ensure the bowl is properly inserted and attached securely to the base. Check for any obstructions or debris preventing the connection.</li> <li>2. If the issue persists after confirming the bowl is correctly inserted contact customer support for further assistance and possible replacement of the sensor.</li> </ol>
<b>Incorrect or no reaction on screen</b>	<ol style="list-style-type: none"> <li>1. Accumulation of dirt or debris on the screen surface, obstructing visibility or affecting touch sensitivity.</li> <li>2. Physical damage to the screen, such as cracks or scratches, impairing its functionality.</li> </ol>	<ol style="list-style-type: none"> <li>1. Clean the screen surface gently with a soft, dry cloth to remove any dirt or debris. Avoid using harsh chemicals or abrasive materials that could further damage the screen.</li> <li>2. If the screen is physically damaged, such as cracked or scratched, it may need to be replaced. Contact customer support for further assistance.</li> </ol>

# PRODUCT SPECIFICATIONS

<b>Product:</b>	Optimum Thermocook Pro M 3.0X
<b>Model:</b>	TCPROM3.0X
<b>Voltage:</b>	220-240V
<b>Frequency:</b>	50-60Hz
<b>Rated Power (Motor):</b>	1400W
<b>Rated Power (Heater):</b>	1000W
<b>Dimension:</b>	43 x 28,5 x 37,2cm (with the stainless steel bowl)
<b>Product weight (net):</b>	9,7kg



At the end of its service life, this product may not be disposed of in the normal household waste, but rather must be disposed of at a collection point for recycling electrical and electronic devices. The materials are recyclable according to their labelling. You make an important contribution to protecting our environment by reusing, recycling or utilizing old devices in other ways. Please ask the municipal administration where the appropriate disposal facility is located.

# WARRANTY TERMS & CONDITIONS

The warranty outlined below only covers distributors of the Optimum range of appliances. Please contact your distributor for a full product warranty.

## Effective as of 1st January 2014

1. Optimum® (“we”) warrants this appliance to be free from defects in materials and workmanship. As long as you use it according to this instruction book, Optimum® warrants that it will perform satisfactorily in household use for a period of 1 year.
2. Any warranties beyond this standard period are offered as extended terms by the selling distributor. This means you can only claim them through that provider.
3. We will repair/replace your appliance if any defects occur under normal use and care within this manufacturers’ warranty period at our discretion, and only if the selling distributor cannot do so. This is done solely at our option with no charge for parts. This warranty does not extend to any accessories, whether included or purchased separately.  
If your distributor determines that your appliance has a major fault, they may offer a replacement at their own discretion.
4. The blade assembly and drive socket will only deteriorate through abuse and misuse. They are therefore only covered by this warranty for up to 30 days after purchase date.
5. If your appliance needs repair while it is under warranty, and your distributor cannot provide the repairs, you are responsible for the cost of returning it to us (or an approved service provider), and also for the cost of returning it back to you.
6. Whilst your appliance is in transit, you assume all risk for it. The warranty does not cover any further damage during transportation.
7. You must ensure that you properly package your appliance when you return it to avoid any damage to it during transit.
8. To enable us to process your warranty claim, ensure you include an explanation of any problem. We will not look for faults for you, and will only repair described faults as covered under warranty.
9. This full warranty is void if your appliance has been subjected to abuse, negligence, accident, alteration, failure to follow operating instructions, or exposed to abnormal or extreme conditions.
9. Cosmetic changes that do not affect performance will not be considered defects or fall under this warranty. These changes include discolouration of any parts of your appliance, or the effects of using abrasive cleaners. The warranty does not cover cleaning or removing any food products from your appliance, or repairing any damage caused by allowing them to build up.
10. This warranty does not cover normal wear and tear on your appliance or its parts.
11. This warranty does not cover any defect caused by an accident, misuse, abuse, improper installation or operation, lack of reasonable care, unauthorised medication, loss of parts, tampering or attempted repair by anyone we have not authorised to make repairs.
12. The warranty will not apply if the damage, malfunction or failure results from alterations, accident, misuse, abuse, fire, liquid spillage, maladjustment of customer controls, use on an incorrect voltage, power surges and dips, thunderstorm activity, acts of God, voltage supply problems, tampering or unauthorised repairs by any persons, use of defective or incompatible , exposure to abnormally corrosive conditions or entry by any insect, vermin or foreign object in the product.
13. The warranty does not cover damage from using your machine with an alternate power source (e.g. solar, inverter, generator, etc.). We do not recommend using these devices to power your appliance.
14. You must keep your purchase docket/receipt as both proof of purchase, and proof of the date on which you made the purchase. You will need to present your purchase docket or receipt when making a claim under this warranty
15. If you do not present your receipt of purchase, this warranty is invalid. Consumer Law allows us to request reasonable proof of purchase to service a warranty claim.
16. This warranty does not imply, intend to or detract from any consumer rights listed in, and able to be enforced from, Regulated Consumer Law. If any condition is found to be in breach of the Consumer Law, only that single condition shall be void; and all other conditions will remain in place.

# CONTACT US

Please contact the distributor located in the Country where you made your original purchase for all Support, Servicing and Warranty.

Your distributor is:



Call to speak to one of our friendly Customer Service Representatives during business hours.

**Australia:** 1300 309 900

**New Zealand:** 0800 741 369

**24/7 After Hours Support, Appliances Faults, Repairs And Warranty.**

**Australia:** [support@froothie.com.au](mailto:support@froothie.com.au)

**New Zealand:** [support@froothie.co.nz](mailto:support@froothie.co.nz)

**TO FIND OUT MORE, VISIT FROOTHIE INTERNATIONAL  
AND SELECT YOUR COUNTRY.**

[www.froothieinternational.com](http://www.froothieinternational.com)



